

Terminals & Cable Ties

Klein solderless terminals and cable ties are engineered to exceptionally high standards for quality and performance. Available in a variety of types and sizes, Klein terminals and cable ties provide fast and easy installations.

F O R P R O F E S S I O N A L S . . . S I N C E 1 8 5 7 ®







Terminals & Cable Ties



Terminals

60000 Series Insulated Bell-Mouth Terminals





- Flared, vinyl insulated sleeve to allow easier insertion of the wire, or wires with extra-heavy-duty insulation.
- Insulation is color coded to indicate wire size; red for 22-18 gauge, blue for 16-14 gauge, and yellow for 12-10 gauge.
- 100 pieces per reusable C-Pack.

	C-Pack Cat. No.	D-Pack Cat. No.	D-Pack Quantity	Sleeve Color	Wire Size	Stud Size	Hole Diameter	Length	Width	Weight Per (oz.)
Ring Tongue										
	C61204	—	—	red	22-18	4	1/8"	51/64"	15/64"	.0224
	C61205	D61205	11	red	22-18	5-6	9/64"	51/64"	7/32"	.0256
	C61206	D61206	11	red	22-18	5-6	9/64"	55/64"	9/32"	.0224
	C61208	D61208	11	red	22-18	8	11/64"	7/8"	21/64"	.0288
	C61210	D61210	11	red	22-18	10	13/64"	7/8"	21/64"	.0288
	C61214	D61214	9	red	22-18	1/4	17/64"	1-1/8"	15/32"	.0427
	C61238	D61238	9	red	22-18	3/8	25/64"	1-17/64"	17/32"	.0391
	C61304	—	—	blue	16-14	4	1/8"	51/64"	1/4"	.0288
	C61305	D61305	11	blue	16-14	5-6	9/64"	51/64"	1/4"	.0288
	C61308	D61308	11	blue	16-14	8	11/64"	61/64"	21/64"	.0352
	C61310	D61310	11	blue	16-14	10	13/64"	61/64"	21/64"	.032
	C61314	D61314	9	blue	16-14	1/4	17/64"	1-5/32"	15/32"	.0462
	C61338	D61338	9	blue	16-14	3/8	25/64"	1-19/64"	17/32"	.0462
	C61406	—	—	yellow	12-10	4-6	9/64"	1-1/32"	3/8"	.064
	C61408	D61408	9	yellow	12-10	8	11/64"	1-1/32"	3/8"	.0569
	C61410	D61410	9	yellow	12-10	10	13/64"	1-1/32"	3/8"	.064
	C61414	D61414	7	yellow	12-10	1/4	17/64"	1-19/64"	33/64"	.0869
	C61438	D61438	7	yellow	12-10	3/8	25/64"	1-13/32"	19/32"	.0823
Spade Tongue										
	C63204	—	—	red	22-18	4	1/8"	3/4"	19/64"	.0192
	C63206	D63206	11	red	22-18	5-6	9/64"	27/32"	19/64"	.0256
	C63208	D63208	11	red	22-18	8	11/64"	59/64"	13/32"	.0352
	C63210	D63210	11	red	22-18	10	13/64"	59/64"	13/32"	.0352
	C63306	D63306	11	blue	16-14	4-6	9/64"	55/64"	19/64"	.0288
	C63308	D63308	11	blue	16-14	8	11/64"	61/64"	13/32"	.0352
	C63310	D63310	11	blue	16-14	10	13/64"	61/64"	13/32"	.0352
	C63406	—	—	yellow	12-10	4-6	9/64"	63/64"	11/32"	.0672
	C63408	D63408	9	yellow	12-10	8	11/64"	63/64"	11/32"	.0533
	C63410	D63410	9	yellow	12-10	10	13/64"	1-1/32"	13/32"	.0604
	C64206*	D64206*	11	red	22-18	4-6	9/64"	57/64"	19/64"	.0224
	Hook Tongue									
	C65206	—	—	red	22-18	4-6	9/64"	57/64"	11/32"	.0288
	C65208	D65208	11	red	22-18	8	11/64"	57/64"	11/32"	.0288
	C65210	—	—	red	22-18	10	13/64"	57/64"	11/32"	.0224
	C65306	—	—	blue	16-14	4-6	9/64"	53/64"	19/32"	.0288
	C65308	D65308	11	blue	16-14	8	11/64"	57/64"	11/32"	.032
	C65310	—	—	blue	16-14	10	13/64"	15/16"	13/32"	.0256
	C65410	—	—	yellow	12-10	10	13/64"	1-1/32"	13/32"	.0608
	Butt Connectors									
	C67202	D67202	11	red	22-18	—	—	1-1/16"	—	.0384
	C67302	D67302	11	blue	16-14	—	—	1-1/16"	—	.048
	C67402	D67402	9	yellow	12-10	—	—	1-1/16"	—	.0888
Pigtail Connectors										
	C67203	D67203	11	—	16-14	—	—	49/64"	5/16"	.0256
	C67405**	D67405	10	—	12-10	—	—	21/32"	27/64"	.048

* With flange. ** This item packaged 50 pieces per C-Pack.



Quick Connects

	Cat. No.	Sleeve Color	Wire Size	Length	Width	Weight Per (oz.)
Male Tab						
	C68202	red	22-18	53/64"	1/4"	.0352
	C68401	yellow	12-10	63/64"	1/4"	.0576
Female Tab						
	C68203	red	22-18	53/64"	1/4"	.0256
	C68403	yellow	12-10	1-1/4"	1/4"	.0480
	C68305	blue	16-14	7/8"	1/4"	.0288
Male Tab (Fully Insulated)						
	C68303*	blue	16-14	1-1/32"	15/32"	.0416
Female Tab (Fully Insulated)						
	C68304	blue	16-14	27/32"	11/32"	.0384
Snap Terminals						
	C69301	blue	16-14	59/64"	5/32"	.0480
	C69303	blue	16-14	51/64"	3/16"	.0448

* This item packaged 50 pieces per C-Pack.

Terminal Sets

Insulated Terminal Kit

- Contains a total of 158 pieces in 15 assorted single-grip insulated terminal styles for a wide variety of general-purpose applications.
- Kit comes in a sturdy see-thru plastic box with 15 compartments, one for each terminal style, for easy organization.
- Includes 158 total terminals of the following; 61205, 61210, 61305, 61310, 61410, 61414, 63206, 63210, 63306, 63310, 67202, 67302, 67402, 68202, and 68305.

Cat. No.	Length	Width	Height	Weight (lbs.)
89976	8-3/4" (222 mm)	4" (102 mm)	1" (25 mm)	.72



89976

Insulated Connect-All Kit

- Contains a total of 74 pieces in 10 assorted single-grip terminal styles for a wide variety of general-purpose applications.
- Kit comes in a sturdy see-thru plastic box with molded tray for easy organization.
- Includes 74 total terminals of the following; 61210, 61310, 61410, 61414, 63310, 64206, 67202, 67302, 67402, and 68305.

Cat. No.	Length	Width	Height	Weight (lbs.)
2398	6-1/2" (165 mm)	5-1/2" (140 mm)	1-5/16" (33 mm)	.49



2398



Nylon Cable Ties

Cable Ties – Standard

- Available in E-Packs of assorted quantities, C-Packs of 100 ties.
- Lengths range from 4-3/16" (107 mm) through 15-1/2" (394 mm), for bundle diameters of 3/4" (19 mm) through 4-1/2" (114 mm).
- Locks permanently in place when pulled tight.
- All-nylon construction.
- Uniform serrations along the length of the tie permit easy pull-through and eliminate slippage.



C70414

C-Pack Cat. No.	Quantity Per Pak	E-Pack Cat. No.	Quantity Per Pak	Maximum Bundle Diameter	Minimum Tensile Strength	Overall Length	Color	Weight Per 10 Pieces (lbs.)
C70412	100	E70412	40	3/4" (19 mm)	18 lbs.	4-3/16" (106 mm)	natural	.06
C70413	100	E70413	32	1-1/4" (32 mm)	30 lbs.	5-3/4" (146 mm)	natural	.01
C70414	100	E70414	20	2" (51 mm)	50 lbs.	8" (203 mm)	natural	.04
C70415	100	E70415	12	4-1/2" (114 mm)	50 lbs.	15-1/2" (394 mm)	natural	.06

Cable Tie – Reusable

- Cat. No. E70416 comes in an E-Pack of 12 ties.
- 8" (203 mm) long, for bundle diameters of up to 1-1/2" (38 mm).
- Locks tightly in place when installed, but can be easily released and reused.
- All-nylon construction.
- Uniform serrations along the length of the tie permit easy pull-through and eliminate slippage.

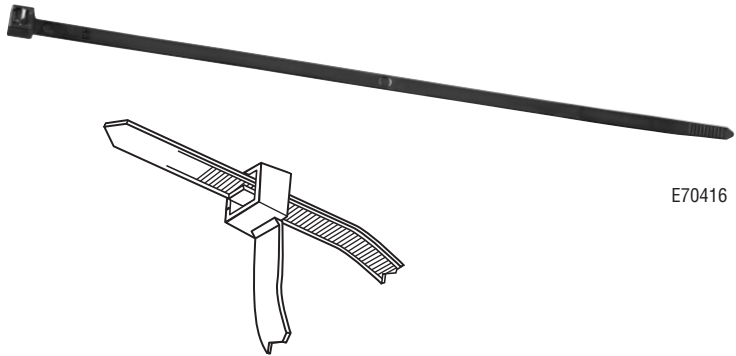

E70416

E-Pack Cat. No.	Quantity Per Pak	Maximum Bundle Diameter	Minimum Tensile Strength	Overall Length	Color	Weight (lbs.)
E70416	12	1-1/2" (38 mm)	50 lbs.	8" (203 mm)	black	.04

Cable Tie Assortment Packs

- Contain various quantities of the most-used cable ties plus holders.

Cat. No.	Contains	Weight (lbs.)
E70417	32-piece assortment contains twenty style Cat. No. 70412 ties, ten style Cat. No. 70413 ties, and two adhesive-back holders	.05
E70418	28-piece assortment contains twelve style Cat. No. 70412 ties, eight style Cat. No. 70413 ties, six style Cat. No. 70414 ties, and two adhesive-back holders	.05

